

# METAL EARTH™

## 3D LASER CUT MODELS

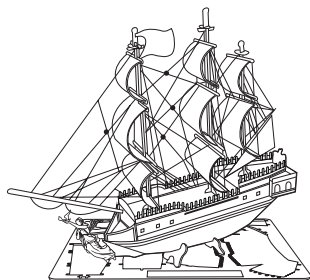

It is highly recommended that you visit [www.fascinations.com/metalearth360/mms012](http://www.fascinations.com/metalearth360/mms012) to see the completed model before assembling your own



mms012

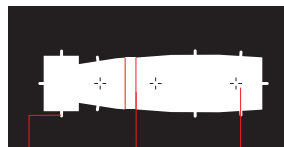

Insertion tabs are inserted and then folded

Fold lines can be seen as shown here

Insertion holes

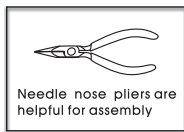

Needle nose pliers are helpful for assembly

### To create the best connections

Insert tab and bend 90 degrees for most visible areas

Insert tab and twist 90 degrees is best in some areas to ensure a tight connection

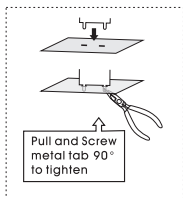

### Metal sheet

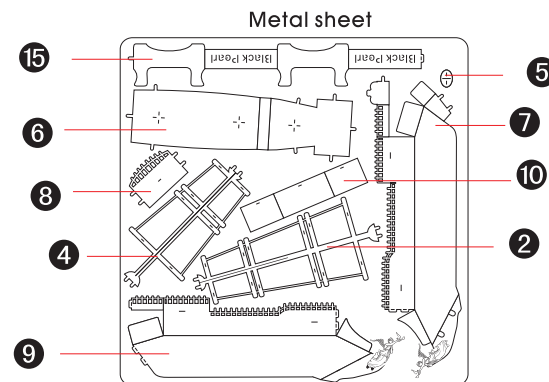
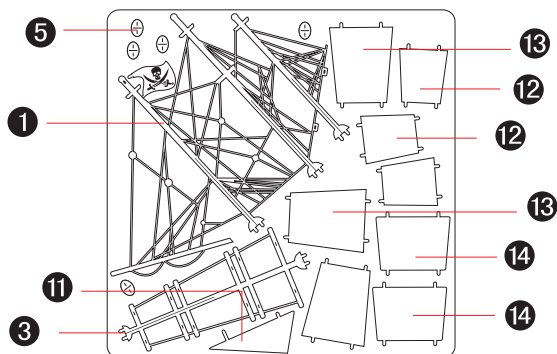

### Assembly Flow Chart

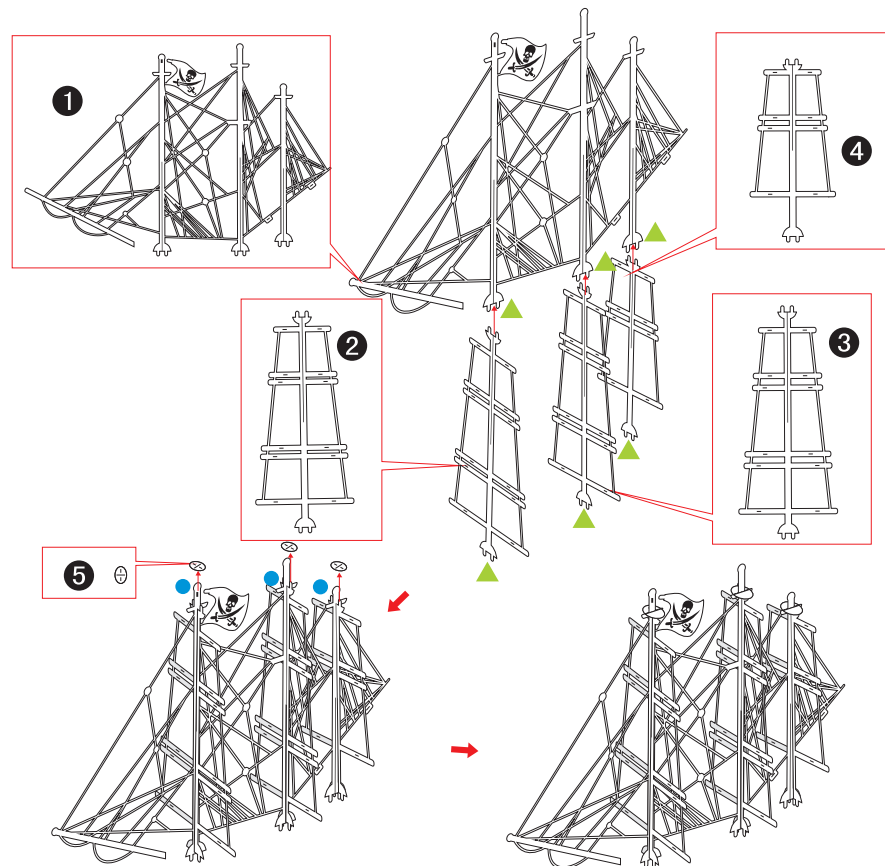

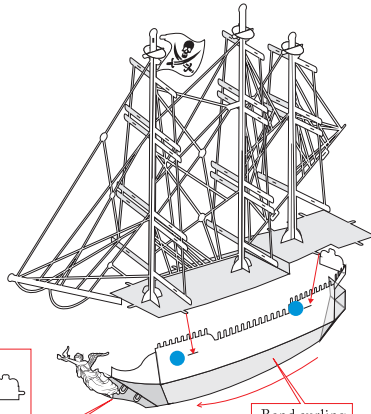
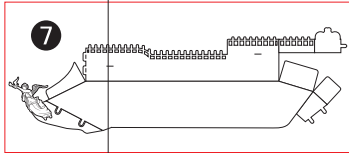
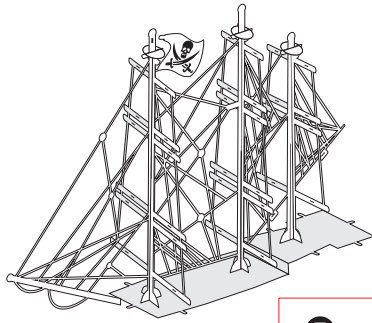
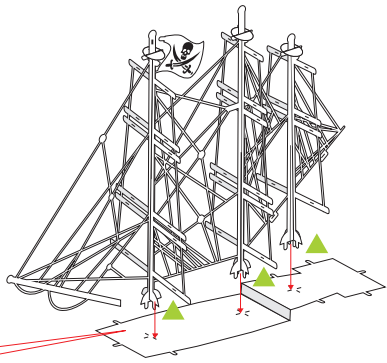
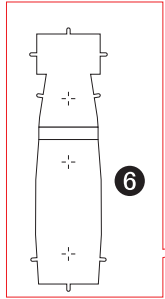

Bend curling by hand

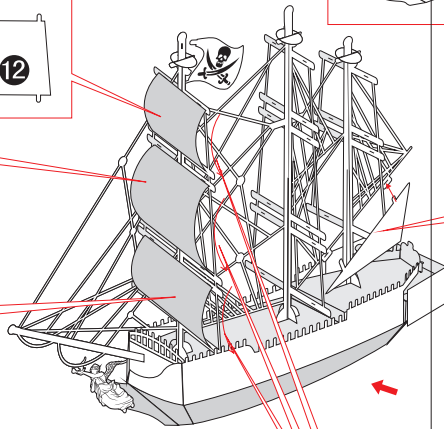
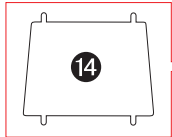
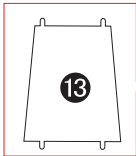
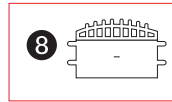
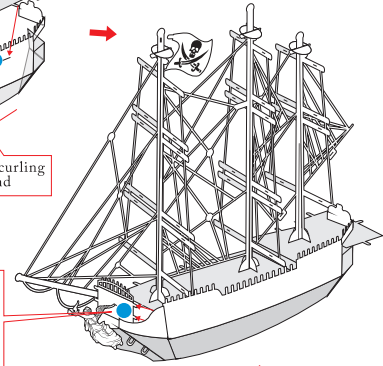

Bend curling by hand

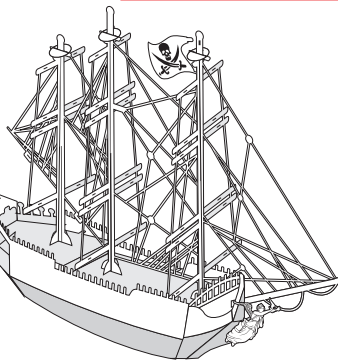
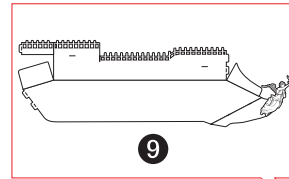
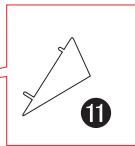

Bend curling by hand

